



# Standard cylinder—SC Series

—Tie-rod type

## Compendium of SC Series

Standard cylinder manufactured by our enterprise

Bore size: 32, 40, 50, 63, 80, 100

Tie-rod cylinder

The cylinder barrel and front/rear cap is jointed by tie rods with high reliability.

Convenient and fast fix sensor switch

Sensor switch can be directly fixed on the cylinder, which is convenient and fast. the counterpart sensor switch type is: CMSG, DMSG, EMSG

Adjustable air buffer

With adjustable air buffer on the front and back cover

Four kinds of cylinder joints



I Knuckle Y Knuckle Floating Joint Universal Joint

Multi-mounting accessories

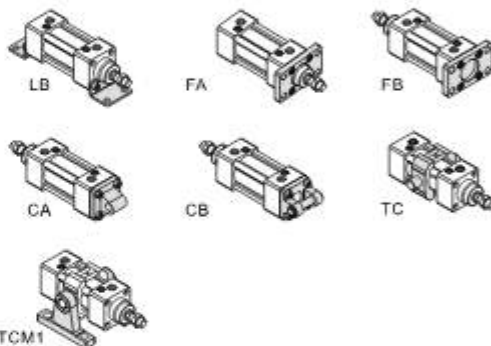

Multi-type cylinder



## Criteria for selection: Cylinder thrust

Unit : Newton(N)

Bore/Rod size	Acting type	Pressure area(mm <sup>2</sup> )	Operating pressure(MPa)								
			0.1	0.2	0.3	0.4	0.5	0.6	0.7	0.8	0.9
32 12	Double acting	804	80.4	160.8	241.2	321.6	402.0	482.4	562.8	643.2	723.6
	Push side / Pull side	690	69.0	138.0	207.0	276.0	345.0	414.0	483.0	552.0	621.0
40 16	Double acting	1256	125.6	251.2	376.8	502.4	628.0	753.6	879.2	1004.8	1130.4
	Push side / Pull side	1055	105.5	211.0	316.5	422.0	527.5	633.0	738.5	844.0	949.5
50 20	Double acting	1963	196.3	392.6	588.9	785.2	981.5	1177.8	1374.1	1570.4	1766.7
	Push side / Pull side	1649	164.9	329.8	494.7	659.6	824.5	989.4	1154.3	1319.2	1484.1
63 20	Double acting	3117	311.7	623.4	935.1	1246.8	1558.5	1870.2	2181.9	2493.6	2805.3
	Push side / Pull side	2803	280.3	560.6	840.9	1121.2	1401.5	1681.8	1962.1	2242.4	2522.7
80 25	Double acting	5028	502.8	1005.6	1507.8	2010.4	2513.0	3015.6	3518.2	4020.8	4523.4
	Push side / Pull side	4536	453.6	907.2	1360.8	1814.4	2268.0	2721.6	3175.2	3628.8	4082.4
100 25	Double acting	7853	785.3	1570.6	2355.9	3141.2	3926.5	4711.8	5497.1	6282.4	7067.7
	Push side / Pull side	7362	736.2	1472.4	2208.6	2944.8	3681.0	4417.2	5153.4	5889.6	6625.8
125 32	Double acting	12272	1227.2	2454.4	3681.6	4908.8	6136.0	7363.2	8590.4	9817.6	11044.8
	Push side / Pull side	11468	1146.8	2293.6	3440.4	4587.2	5734.0	6880.8	8027.6	9174.4	10321.2
160 40	Double acting	20106	2010.6	4021.2	6031.8	8042.4	10053.0	12063.6	14074.2	16084.8	18095.4
	Push side / Pull side	18849	1884.9	3769.8	5654.7	7539.6	9424.5	11309.4	13194.3	15079.2	16964.1
200 40	Double acting	31416	3141.6	6283.2	9424.8	12566.4	15708.0	18849.6	21991.2	25132.8	28274.4
	Push side / Pull side	30159	3015.9	6031.8	9047.7	12063.6	15079.5	18095.4	21111.3	24127.2	27143.1
250 50	Double acting	49087	4908.7	9817.4	14726.1	19634.8	24543.5	29452.2	34360.9	39269.6	44178.3
	Push side / Pull side	47124	4712.4	9424.8	14137.2	18849.6	23562.0	28274.4	32986.8	37699.2	42411.6

## Installation and application



1. When load changes in the work, the cylinder with abundant output capacity shall be selected.
2. Relative cylinder with high temperature resistance or corrosion resistance shall be chosen under the condition of high temperature or corrosion.
3. Necessary protection measure shall be taken in the environment with higher humidity, much dust or water drops, oil dust and welding drogs.
4. Dirty substances in the pipe must be eliminated before cylinder is connected with pipeline to prevent the entrance of particles into the cylinder.
5. The medium used by cylinder shall be filtered to 40µm or below.
6. Anti-freezing measure shall be adopted under low temperature environment to prevent moisture freezing.
7. The cylinder shall be carried out test run without load before application. Prior to run, buffer shall be turned to the minimum and gradually released to avoid the damage on cylinder caused by excessive impact.
8. The cylinder shall avoid the influence of side load in operation to maintain the normal work of cylinder and extend the service life.
9. If the cylinder is dismantled and stored for a long time, please conduct anti-rust treatment to the surface. Anti-dust caps shall be added in air inlet and outlet ports.

# Standard cylinder(Tie-rod)

## SC Series



### Symbol

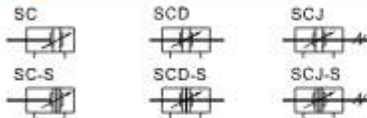

### Specification

Bore size(mm)	32	40	50	63	80	100
Acting type	Double acting					
Fluid	Air(to be filtered by 40µm filter element)					
Mounting type	SC	Basic FA FB CA CB LB TC TCM1				
	SCD, SCJ	Basic FA LB TC TCM1				
Operating pressure	0.15~1.0MPa(22~145psi)(1.5~10.0bar)					
Proof pressure	1.5MPa(215psi)(15bar)					
Temperature °C	-20~70					
Speed range mm/s	30~800					
Stroke tolerance	0~250 <sup>+1.0</sup> / <sub>0</sub>		251~1000 <sup>+1.5</sup> / <sub>0</sub>		1001~1500 <sup>+2.0</sup> / <sub>0</sub>	
Cushion type	Variable cushion					
Adjustable cushion stroke	21		28		29	
Port size [Note 1]	1/8"		1/4"		3/8"	
					1/2"	

[Note 1] PT thread, G thread are available.  
Add) Refer to P362 for detail of sensor switch.

### Product feature

- Standard cylinder manufactured by our enterprise.
- The seal of piston adopts heterogeneous two way seal structure. It's dimension is light and it has the function of grease reservation.
- It is tie rod cylinder. The cylinder barrel and front/rear cap is jointed by tie rods with high reliability.
- Compared with ISO15552 standard cylinder, SC series cylinder with the same bore size is shorter.
- The buffer adjustment of cylinder is smooth and steady.
- Cylinders and mounting accessories with several specifications are optional.
- The seal material with high temperature resistance is adopted, operating temperature range is 0~150°C.

### Stroke

Bore size (mm)	Standard stroke (mm)															Max.std stroke	Max. stroke
	25	50	75	80	100	125	150	160	175	200	250	300	350	400	450		
32																1000	2000
40																1200	2000
50																1200	2000
63																1500	2000
80																1500	2000
100																1500	2000

[Note] If the stroke is ≥1600mm within the maximum stroke scope, it is treated as non-standard one.  
Please contact the company for other special strokes.

### Ordering code

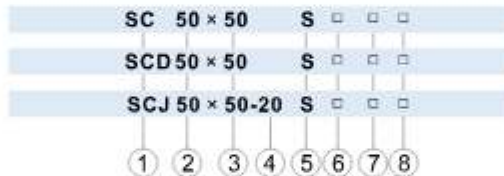

① Model	② Bore size	③ Stroke	④ Adjustable stroke	⑤ Magnet	⑥ Mounting type[Note 1]	⑦ Seals Material	⑧ Thread type
SC: Double acting type	32 40 50 63 80 100	Refer to stroke table for details	No this code	Blank: Without magnet S: With magnet	Blank LB FA FB CA CB TC	Blank: TPU H: Viton N: NBR	Blank: PT G: G
SCD: Double rod type					Blank LB		
SCJ: Adjustable stroke type		10 20 30 40 50 75 100			FA TC		

[Note 1] The accessories are the same as SAU series, please refer to page 41~44 for details ;  
TC is used with TCM1 and can't be ordered by separately, it must be ordered together with the cylinder.

## SC Series

### Inner structure and material of major parts

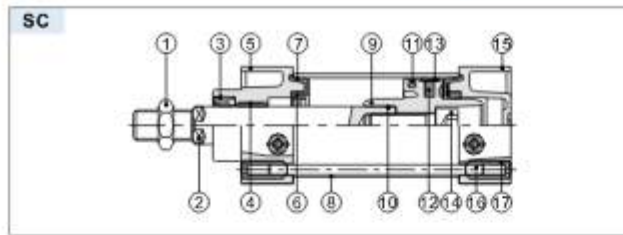

Note: inner structure & material data sheet is based on certain bore size. Please contact AirTAC if you need inner structure & material data sheet for specific bore size.

NO.	Item	Material
1	Rod nut	Carbon steel
2	Piston rod	Carbon steel with 20μm chrome plated
3	Front cover packing	TPU
4	Bushing	Wear resistant material
5	Front cover	Aluminum alloy
6	Cushing O-ring	NBR
7	Cushion gasket	TPU
8	Barrel	Aluminum alloy
9	Piston	Aluminum alloy
10	Piston rod O-ring	NBR
11	Piston seal	NBR
12	Magnet	Plastic
13	Wear ring	Wear resistant material
14	Bolt	Carbon steel
15	Back cover	Aluminum alloy
16	Tie-rod	Carbon steel
17	Tie-rod nut	Carbon steel

### Dimensions

#### SC

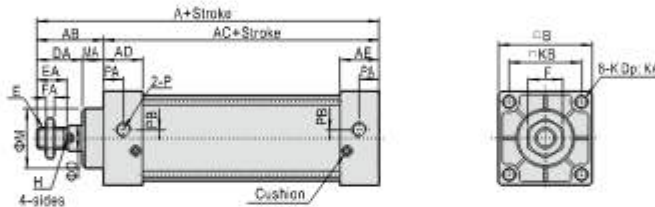

Bore size/Item	A	AB	AC	AD	AE	B	D	DA	E	EA	F	FA	H	K	KA	KB	M	MA	P	PA	PB
32	140	47	93	27.5	27.5	45	12	32	M10×1.25	22	17	6	10	M6×1.0	14.5	33	28	15	1/8"	14	5.5
40	142	49	93	27.5	27.5	50	16	34	M12×1.25	24	17	7	13	M6×1.0	14.5	37	32	15	1/4"	15	6
50	150	57	93	27.5	27.5	62	20	42	M16×1.5	32	23	8	17	M6×1.0	14.5	47	38	15	1/4"	17	8.5
63	153	57	96	27.5	27.5	75	20	42	M16×1.5	32	23	8	17	M8×1.25	14.5	56	38	15	3/8"	15	9.5
80	182	75	107	33	33	94	25	54	M20×1.5	40	26	10	22	M10×1.5	17	70	47	21	3/8"	19.5	10
100	188	75	113	33	33	112	25	54	M20×1.5	40	26	10	22	M10×1.5	17	84	47	21	1/2"	16.5	11

Remark: The dimensions of magnet type cylinder are the same as non-magnet type cylinder.

#### SCD

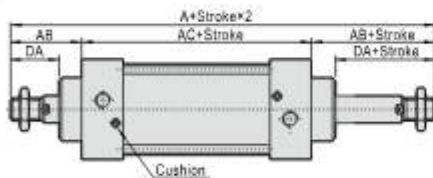

#### SCJ

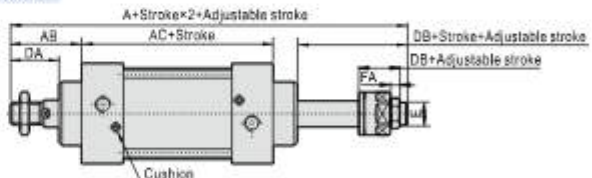

Bore size/Item	A(SCD)	A(SCJ)	AB	AC	DA	DB	E	FA
32	187	182	47	93	32	27	M10X1.25	6
40	191	185	49	93	34	28	M12X1.25	7
50	207	194	57	93	42	29	M16X1.5	8
63	210	197	57	96	42	29	M16X1.5	8
80	257	238.5	75	107	54	35.5	M20X1.5	10
100	263	244.5	75	113	54	35.5	M20X1.5	10

Remark:

- The dimensions of magnet type cylinder are the same as non-magnet type cylinder.
- The unmarked dimension is the same as SC standard type.



# Standard cylinder(Tie-rod)

## SC Series——Big bore size type



### Symbol

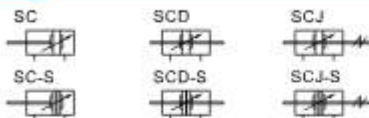

### Specification

Bore size(mm)	125	160	200	250
Acting type	Double acting			
Fluid	Air(to be filtered by 40µm filter element)			
Mounting type	Basic FA FB CA CB LB TC TCM1			
SC type	SCD, SCJ			
SCJ type	Basic FA LB TC TCM1			
Operating pressure	0.15~1.0MPa(22~145psi)(1.5~10.0bar)			
Proof pressure	1.5MPa(215psi)(15bar)			
Temperature °C	-20~70			
Speed range mm/s	30~500			
Stroke tolerance	0~250 <sup>+1.0</sup> <sub>0</sub>	251~1000 <sup>+1.0</sup> <sub>0</sub>	1001~1500 <sup>+2.0</sup> <sub>0</sub>	
Cushion type	Variable cushion			
Adjustable cushion stroke	28	29	33	40
Port size [Note 1]	1/2"	3/4"		1"

[Note 1] PT thread, G thread are available.  
Add) Refer to P362 for detail of sensor switch.

### Product feature

- ISO6430 standard cylinder.
- The seal of piston adopts heterogeneous two way seal structure. It's dimension is tight and it has the function of grease reservation.
- It is tie rod cylinder. The cylinder barrel and front/rear cap is jointed by tie rods with high reliability.
- Compared with ISO15552 standard cylinder, SC series cylinder with the same bore size is shorter.
- The buffer adjustment of cylinder is smooth and steady.
- Cylinders and mounting accessories with several specifications are optional.
- The seal material with high temperature resistance is adopted, operating temperature range is 0~150°C.

### Stroke

Bore size (mm)	Standard stroke (mm)										Max. std. stroke	Max. stroke											
125	25	50	75	80	100	125	150	160	175	200	250	300	350	400	450	500	600	700	800	900	1000	1500	2000
160	25	50	75	80	100	125	150	160	175	200	250	300	350	400	450	500	600	700	800	900	1000	1500	2000
200	25	50	75	80	100	125	150	160	175	200	250	300	350	400	450	500	600	700	800	900	1000	1500	2000
250	25	50	75	80	100	125	150	160	175	200	250	300	350	400	450	500	600	700	800	900	1000	1500	2000

[Note] Please contact the company for other special strokes.

### Ordering code



① Model	② Bore size	③ Stroke	④ Adjustable stroke	⑤ Magnet	⑥ Mounting type[Note 1]	⑦ Seals Material	⑧ Thread type
SC: Double acting type	125 160 200 250	Refer to stroke table for details	No this code	Blank: Without magnet S: With magnet	Blank LB FA FB CA CB TC	Blank: NBR H: Viton	Blank: PT G: G
SCD: Double rod type					Blank LB		
SCJ: Adjustable stroke type			10 20 30 40 50 75 100		FA TC		

[Note 1] Please refer to page 41~44 for accessory parts. TC is used with TCM1.



# Standard cylinder(Tie-rod)

## SC Series—Big bore size type

### Inner structure and material of major parts

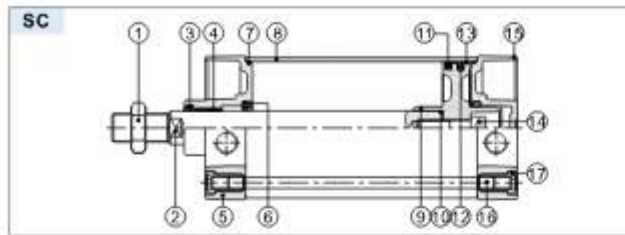

Note: inner structure & material data sheet is based on certain bore size. Please contact AirTAC if you need inner structure & material data sheet for specific bore size.

NO.	Item	Material
1	Rod nut	Carbon steel
2	Piston rod	Carbon steel with 20μm chrome plated
3	Front cover packing	TPU
4	Bushing	Wear resistant material
5	Front cover	Aluminum alloy
6	Cushioning O-ring	TPU
7	O-ring	NBR
8	Barrel	Aluminum alloy
9	Piston	Aluminum alloy
10	Piston rod O-ring	NBR
11	Piston seal	NBR
12	Magnet	Plastic
13	Wear ring	Wear resistant material
14	Bolt	Carbon steel
15	Back cover	Aluminum alloy
16	Tie-rod	Carbon steel
17	Tie-rod nut	Carbon steel

### Dimensions

#### SC

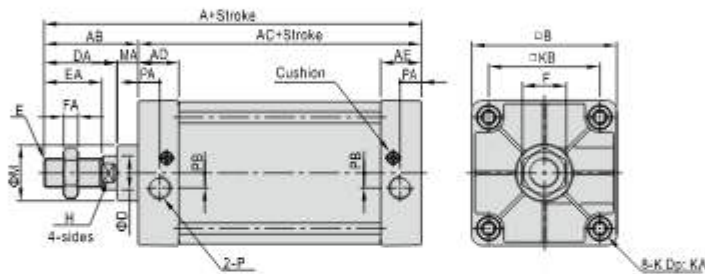

Bore size/Item	A	AB	AC	AD	AE	B	D	DA	E	EA	F	FA	H	K	KA	KB	M	MA	P	PA	PB
125	203	88	115	38	38	136	32	68	M27×2.0	54	41	13.5	27	M12×1.75	21.5	104	52	20	1/2"	20	14
160	239	113	128	38	38	174	40	88	M36×2.0	72	55	18	36	M16×2.0	21	134	62	25	3/4"	20	15
200	244	118	126	38	38	214	40	88	M36×2.0	72	55	18	36	M16×2.0	21	163	62	30	3/4"	20	15
250	294	141	153	48	48	267	50	106	M42×2.0	84	65	21	46	M20×2.5	26.5	202	86	35	1"	25.5	22

Remark: The dimensions of magnet type cylinder are the same as non-magnet type cylinder.

#### SCD

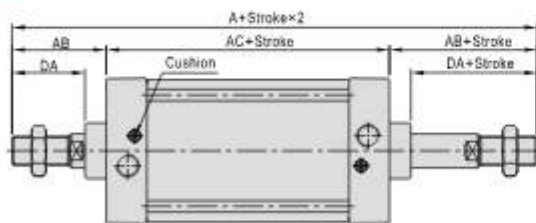

#### SCJ

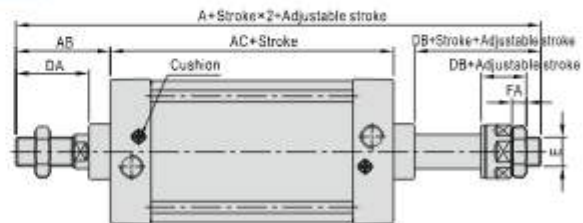

Bore size/Item	A(SCD)	A(SCJ)	AB	AC	DA	DB	E	FA
125	291	265.5	88	115	68	42.5	M27X2.0	13.5
160	352	332	113	128	88	68	M36X2.0	18
200	362	342	118	126	88	68	M36X2.0	18
250	435	409	141	153	106	80	M42X2.0	21

Remark:

- The dimensions of magnet type cylinder are the same as non-magnet type cylinder.
- The unmarked dimension is the same as SC standard type.

# Standard cylinder(Tie-rod)

## SCT Series—Multi-position type



### Symbol



### Product feature

- Standard cylinder manufactured by our enterprise.
- The seal of piston adopts heterogeneous two way seal structure. It's dimension is tight and it has the function of grease reservation.
- It is tie rod cylinder. The cylinder barrel and front/rear cap is jointed by tie rods with high reliability.
- Piston rod can be positioned in several positions in the whole action process.

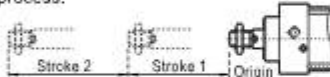

- The buffer adjustment of cylinder is smooth and steady.
- Cylinders and mounting accessories with several specifications are optional.
- The seal material with high temperature resistance is adopted, operating temperature range is 0-150°C.

### Ordering code

SCT 50 × 50 × 50 S □ □ □

① ② ③ ④ ⑤ ⑥ ⑦ ⑧

① Model	② Bore size	③ Stroke 1	④ Stroke 2	⑤ Magnet	⑥ Mounting type[Note1]	⑦ Seals Material	⑧ Thread type
SCT: Double acting Multi-position type	32 40 50 63 80 100	Refer to stroke table for details	Refer to stroke table for details	Blank: Without magnet S: With magnet	Blank	Blank: TPU H: Viton N: NBR	Blank: PT G: G
					LB		
					FA		
					FB		
					CA		
					CB		

[Note1] Please refer to page 41-44 for accessory parts. TC is used with TCM1.

### Specification

Bore size(mm)	32	40	50	63	80	100
Acting type	Double acting					
Fluid	Air(to be filtered by 40µm filter element)					
Mounting type	Basic FA FB CA CB LB TC TCM1					
Operating pressure	0.15~1.0MPa(22~145psi)(1.5~10.0bar)					
Proof pressure	1.5MPa(215psi)(15bar)					
Temperature °C	-20~70					
Speed range mm/s	30~800					
Stroke tolerance	0~250 <sup>+1.0</sup> <sub>0</sub>		251~1000 <sup>+1.5</sup> <sub>0</sub>		1001~1500 <sup>+2.0</sup> <sub>0</sub>	
Cushion type	Variable cushion					
Adjustable cushion stroke	21			28		29
Port size [Note1]	1/8"	1/4"	3/8"		1/2"	

[Note1] PT thread, G thread are available.

Add) Refer to P362 for detail of sensor switch.

### Stroke

Bore size (mm)	Standard stroke (mm)															Max. std stroke	Max. stroke
	25	30	35	40	45	50	60	70	80	90	100	125	150	160	175		
32	25	30	35	40	45	50										500	800
40	25	30	35	40	45	50										500	800
50	25	30	35	40	45	50										500	800
63	25	30	35	40	45	50										500	800
80	25	30	35	40	45	50										500	800
100	25	30	35	40	45	50										500	800

[Note] If the stroke is ≥800mm within the maximum stroke scope, it is treated as non-standard one.

Please contact the company for other special strokes.



# Standard cylinder(Tie-rod)

## SCT Series—Multi-position type

### Inner structure and material of major parts

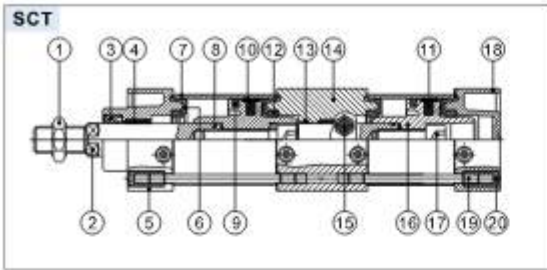

NO.	Item	Material	NO.	Item	Material
1	Rod nut	Carbon steel	11	Magnet	Plastic
2	Piston rod	Carbon steel with 20μm chrome plated	12	Gasket	NBR
3	Packing	TPU	13	O-ring	NBR
4	Bushing	Wear resistant material	14	Joint seat	Aluminum alloy
5	Front cover	Aluminum alloy	15	Silencer	
6	Cushing O-ring	TPU	16	Piston	Aluminum alloy
7	Barrel	Aluminum alloy	17	Bolt	Carbon steel
8	Rod O-ring	NBR	18	Back cover	Aluminum alloy
9	Piston seal	NBR	19	Tie-rod	Carbon steel
10	Wear ring	Wear resistant material	20	Tie-rod nut	Carbon steel

Note: inner structure & material data sheet is based on certain bore size. Please contact AirTAC if you need inner structure & material data sheet for specific bore size.

### Dimensions

#### SCT

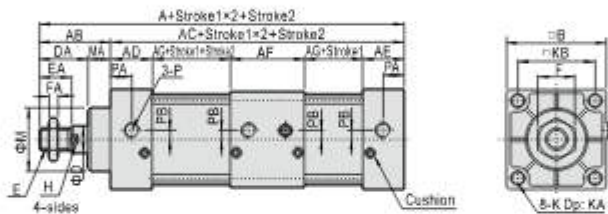

Bore size/Item	A	AB	AC	AD	AE	AF	AG	B	D	DA	E	EA	F	FA	H	K	KA	KB	M	MA	P	PA	PB
32	233	47	186	27.5	27.5	55	38	45	12	32	M10×1.25	22	17	6	10	M6×1.0	14.5	33	28	15	1/8"	14	5.5
40	235	49	186	27.5	27.5	55	38	50	16	34	M12×1.25	24	17	7	13	M6×1.0	14.5	37	32	15	1/4"	15	6
50	243	57	186	27.5	27.5	55	38	62	20	42	M16×1.5	32	23	8	17	M6×1.0	14.5	47	38	15	1/4"	17	8.5
63	249	57	192	27.5	27.5	55	41	75	20	42	M16×1.5	32	23	8	17	M8×1.25	14.5	56	38	15	3/8"	15	9.5
80	296	75	221	33	33	73	41	94	25	54	M20×1.5	40	26	10	22	M10×1.5	17	70	47	21	3/8"	19.5	10
100	308	75	233	33	33	73	47	112	25	54	M20×1.5	40	26	10	22	M10×1.5	17	84	47	21	1/2"	16.5	11

Remark: The dimensions of magnet type cylinder are the same as non-magnet type cylinder.

## SC Series—Accessories

### List for ordering code of accessories

Accessories	Mounting accessories					
	LB	FA/FB	CA	CB	TC	TCM1
32	F-SC32LB	F-SC32FA	F-SC32CA	F-SC32CB	F-SC32TC	F-SM40TCM1
40	F-SC40LB	F-SC40FA	F-SC40CA	F-SC40CB	F-SC40TC	F-SC40TCM1
50	F-SC50LB	F-SC50FA	F-SC50CA	F-SC50CB	F-SC50TC	F-SC40TCM1
63	F-SC63LB	F-SC63FA	F-SC63CA	F-SC63CB	F-SC63TC	F-SC40TCM1
80	F-SC80LB	F-SC80FA	F-SC80CA	F-SC80CB	F-SC80TC	F-SC80TCM1
100	F-SC100LB	F-SC100FA	F-SC100CA	F-SC100CB	F-SC100TC	F-SC80TCM1
125	F-SC125LB	F-SC125FA	F-SC125CA	F-SC125CB	F-SC125TC	F-SC125TCM1
160	F-SC160LB	F-SC160FA	F-SC160CA	F-SC160CB	F-SC160TC	F-SC160TCM1
200	F-SC200LB	F-SC200FA	F-SC200CA	F-SC200CB	F-SC200TC	F-SC160TCM1
250	F-SC250LB	F-SC250FA	F-SC250CA	F-SC250CB	F-SC250TC	F-SC250TCM1

Accessories	Knuckle				Sensor switch		
	I: I Knuckle	Y: Y Knuckle	F: F Knuckle	U: U Knuckle	CMSG	DMSG	EMSG
32	F-M10X125I	F-M10X125Y	F-M10X125F	F-M10X125U	CMSG	DMSG	EMSG
40	F-M12X125I	F-M12X125Y	F-M12X125F	F-M12X125U			
50	F-M16X150I	F-M16X150Y	F-M16X150F	F-M16X150U			
63	F-M16X150I	F-M16X150Y	F-M16X150F	F-M16X150U			
80	F-M20X150I	F-M20X150Y	F-M20X150F	F-M20X150U			
100	F-M20X150I	F-M20X150Y	F-M20X150F	F-M20X150U			
125	F-M27X200I	F-M27X200Y	F-M27X200F	F-M27X200U			
160	F-M36X200I	F-M36X200Y	F-M36X200F	F-M36X200U			
200	F-M36X200I	F-M36X200Y	F-M36X200F	F-M36X200U			
250	F-M42X200Y	F-M42X200Y	-	-			

### Accessory selection

Accessories	Mounting accessories							Knuckle [Note1]				Sensor switch		
	LB	FA	FB	CA	CB	TC	TCM1	I	Y	U	F	CMSG	DMSG	EMSG
SC	Standard	●	●	●	●	●	●	●	●	●	●	●	●	●
	With magnet	●	●	●	●	●	●	●	●	●	●	●	●	●
SCD	Standard	●	●	x	x	x	●	●	●	●	●	●	●	●
	With magnet	●	●	x	x	x	●	●	●	●	●	●	●	●
SCJ	Standard	●	●	x	x	x	●	●	●	●	●	x	x	x
	With magnet	●	●	x	x	x	●	●	●	●	●	●	●	●
SCT	Standard	●	●	●	●	●	x	x	●	●	●	●	x	x
	With magnet	●	●	●	●	●	x	x	●	●	●	●	●	●

[Note1] Please refer to P358~361 for knuckle detail.

### Material of accessories

Accessories	Mounting accessories							Knuckle			
	LB	FA	FB	CA	CB	TC	TCM1	I	Y	F	U
32~100	□	■	■	○	○	○	○	□	□	□	□
125~200	○	○	○	○	○	○	○	□	□	□	□
250	○	■	■	○	○	○	○	■	■	-	-

●—Aluminum alloy, ■—Cast steel, ○—Nodular cast iron, □—Carbon steel.



### Dimensions

#### LB

φ32-φ100

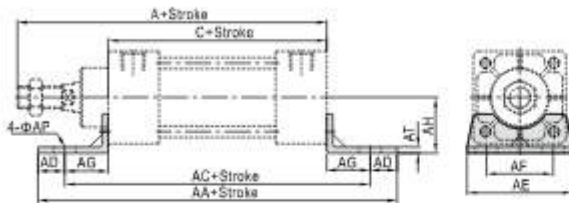

#### CA

φ32-φ100

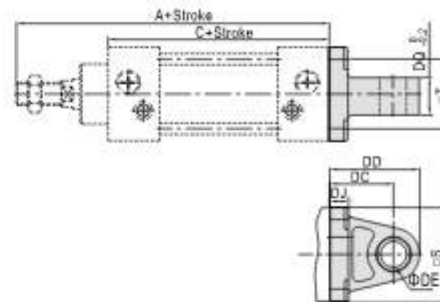

φ125-φ250

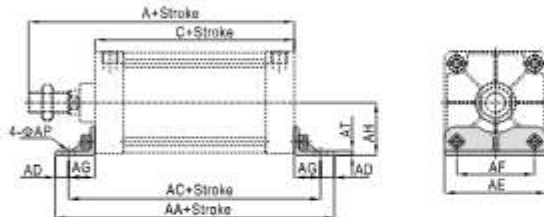

φ125-φ250

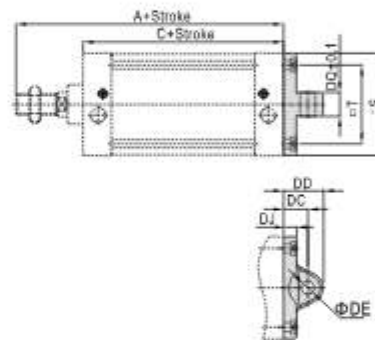

Bore size/Item	A	C	AA	AC	AD	AE	AF	AG	AH	AP	AT
32	140	93	153	134	9.5	50	33	20.5	28	9	3
40	142	93	169	140	14.5	57	36	23.5	30	12	3
50	150	93	173	149	12	68	47	28	36.5	12	3
63	153	96	184	158	13	80	56	31	41	12	3
80	182	107	199	167	16	97	70	30	49	14	4
100	188	113	209	173	18	112	84	30	57	14	4
125	203	115	221	185	18	136	104	35	70	17	6
160	239	126	246	206	20	174	134	40	91	17	8
200	244	126	276	226	25	214	183	50	113.5	22	9
250	294	153	323	273	25	267	201	60	141	26	15

Bore size/Item	A	C	DC	DD	DE	DJ	DQ	S	T
32	140	93	34	44.5	12	9	16	45	33
40	142	93	34	45.5	14	9	20	49	37
50	150	93	34	46	14	10	20	61	47
63	153	96	34	46.5	14	10	20	74	56
80	182	107	48	64.5	20	14	32	93	70
100	188	113	48	65	20	14	32	111	84
125	203	115	32	52	20	17	31.7	135	104
160	239	126	40	68	28	19.5	39.7	173	134
200	244	126	60	90	28	23	39.7	213	163
250	294	153	70	106	36	24	49.7	255	202

## SC Series—Accessories

### FA/FB

Φ32-Φ100

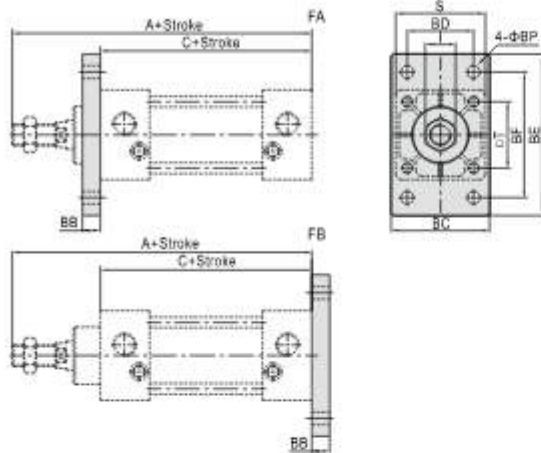

### CB

Φ32-Φ100

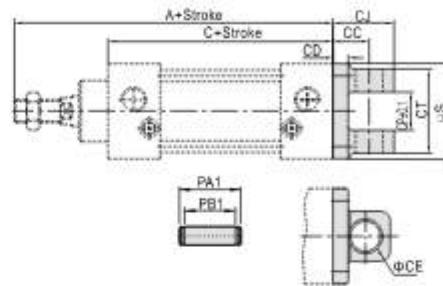

Φ125-Φ250

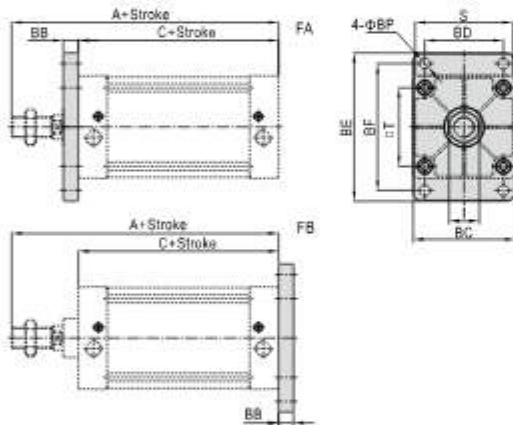

Φ125-Φ250

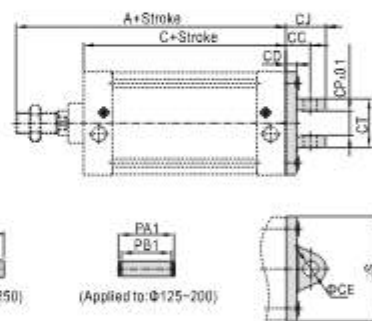

(Applied to Φ250)

(Applied to Φ125-200)

Bore size/Item	A	C	BB	BC	BD	BE	BF	BP	I	S	T
32	140	93	10	47	33	80	58	7	17	45	33
40	142	93	10	53	36	90	70	7	17	50	37
50	150	93	10	65	47	104	86	9	23	62	47
63	153	96	12	75	56	118	98	9	23	75	56
80	182	107	16	95	70	140	119	11	28	94	70
100	188	113	16	115	84	180	138	11	26	112	84
125	203	115	20	135	104	196	168	14	41	136	104
160	239	126	20	173	134	248	212	18	55	174	134
200	244	126	25	213	163	286	250	18	55	214	163
250	294	153	25	255	201	358	312	22	65	267	202

Bore size/Item	A	C	S	CC	CD	CE	CJ	CP	CT	PA1	PB1
32	140	93	45	19	9	12	29.5	16.3	32	39	32.8
40	142	93	49	19	9	14	30.5	20.3	44	51	44.8
50	150	93	61	19	10	14	31	20.3	52	59	52.8
63	153	96	74	19	10	14	31.5	20.3	52	59	52.8
80	182	107	93	32	14	20	48.5	32.3	64	73	64.8
100	188	113	111	32	14	20	49	32.3	64	73	64.8
125	203	115	135	32	14	20	52	32.1	64	73	64.8
160	239	126	173	40	15	28	68	40.1	80	90.2	80.8
200	244	126	213	60	23	28	90	40.1	80	90.2	80.8
250	294	153	255	70	24	38	108	50.1	100	130	108

## SC Series—Accessories

### TC

Φ32-Φ100

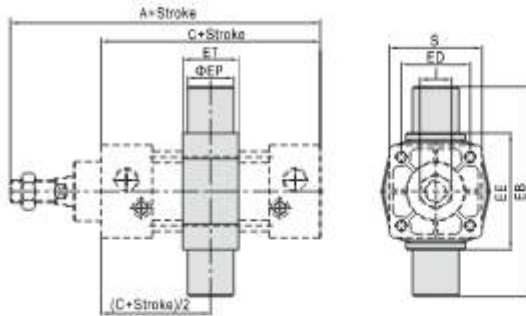

### TCM1

Φ32-Φ100

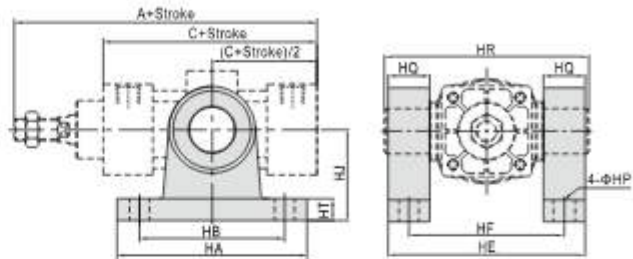

Φ125-Φ250

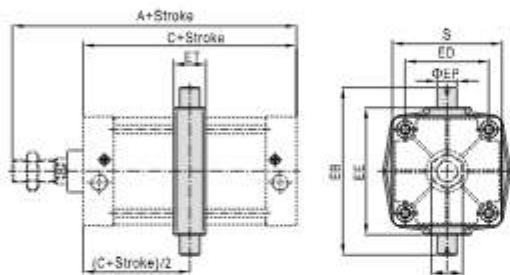

Φ125-Φ250

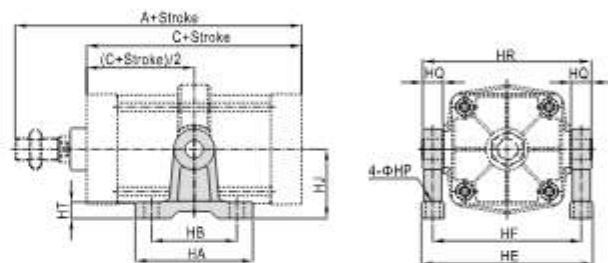

Bore size/Item	A	C	EB	ED	EE	EP	ET	I	S
32	140	93	87	33	55	16	22	17	45
40	142	93	113	37	63	25	28	17	50
50	150	93	126	47	76	25	28	23	62
63	153	96	138	56	88	25	30	23	75
80	182	107	164	70	114	25	32	26	94
100	188	113	182	84	132	25	38	28	112
125	203	115	208	104	158	25	40	41	136
160	239	126	272	134	200	36	46	55	174
200	244	126	318	163	246	36	48	55	214
250	294	153	394	202	304	45	56	65	267

[Note] The installation position of the accessories can not be adjusted arbitrarily.

Bore size/Item	A	C	HA	HB	HE	HF	HP	HQ	HR	HT	HJ
32	140	93	100	75	90	71	12	16	87	11	54
40	142	93	103	80	109	86	11	23	113	12	50
50	150	93	103	80	122	99	11	23	126	12	50
63	153	96	103	80	134	111	11	23	138	12	50
80	182	107	110	85	160	137	13	23	164	12	70
100	188	113	110	85	178	155	13	23	182	12	70
125	203	115	145	105	211	183	18	25	208	20	85
160	239	126	185	140	272	236	22	36	272	25	130
200	244	126	185	140	318	282	22	36	318	25	130
250	294	153	215	165	394	349	26	45	394	28	160

[Note] The installation position of the accessories can not be adjusted arbitrarily.